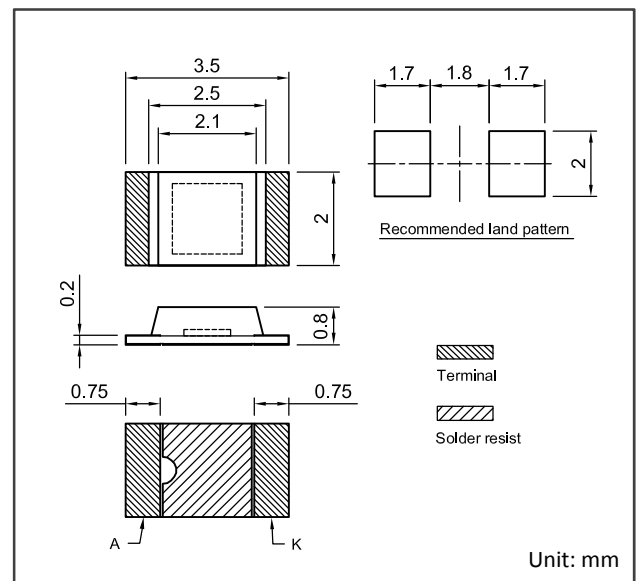

Features

- Transparent epoxy mold
- High sensitivity
- SMD type package

Applications

- Optical switches
- Optical encoders
- Pulse detectors
- Sensors and industrial controls

**Absolute Maximum Ratings**

| Parameter | Symbol | Value | Unit | Note |
|-----------------------|-----------|-------------|------|------------------------|
| Reverse voltage | V_R | 10 | V | |
| Reverse current | I_R | 1 | mA | |
| Forward current | I_F | 10 | mA | |
| Operating temperature | T_{opr} | -20 to +80 | °C | Avoid dew condensation |
| Storage temperature | T_{stg} | -20 to +100 | °C | Avoid dew condensation |
| Soldering temperature | T_{sol} | 260 | °C | Max 5 sec. |

Electrical and Optical Characteristics (Ta=25°C unless otherwise noted)

| Parameter | Symbol | Min. | Typ. | Max. | Unit | Test Condition |
|-----------------------|-----------|-------------|--------------------|------|-----------------|------------------------------|
| Active area | S | 1.25 x 1.25 | | | mm ² | |
| Sensitive wavelength | λ | 400 | 950(λ_p) | 1100 | nm | λ_p =Peak wavelength |
| Open circuit voltage | V_{op} | - | 400 | - | mV | 1000lx @2856K |
| Short circuit current | I_{sh} | - | 15 | - | μ A | 1000lx @2856K |
| Dark current | I_D | - | - | 10 | nA | $V_R=5V$ |
| Terminal capacitance | C_t | - | 6 | - | pF | $V_R=5V, f=1MHz$ |
| Half angle | 2θ | - | 140 | - | deg. | |

Dark Current - Reverse Voltage

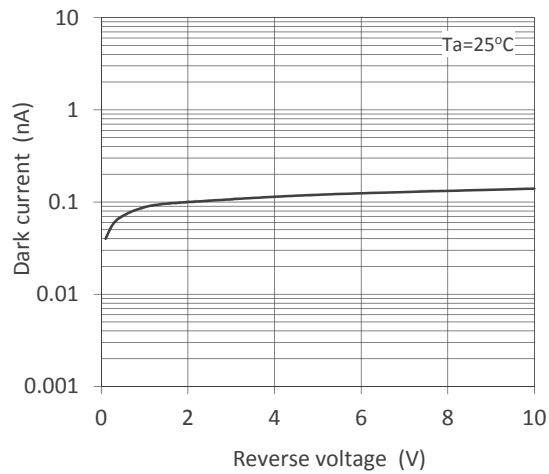

Photocurrent - Ambient Temperature

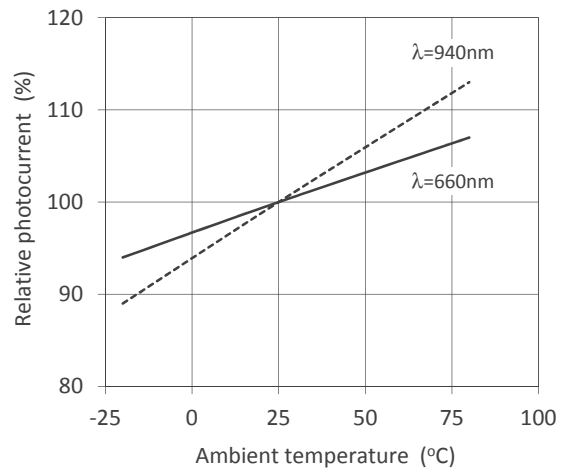

Photocurrent - Illuminance

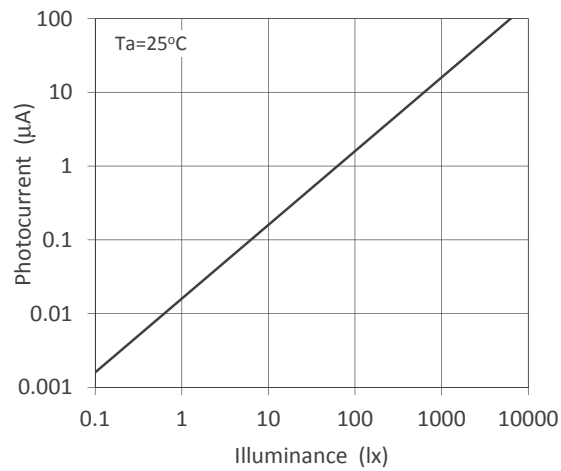

Dark Current - Ambient Temperature

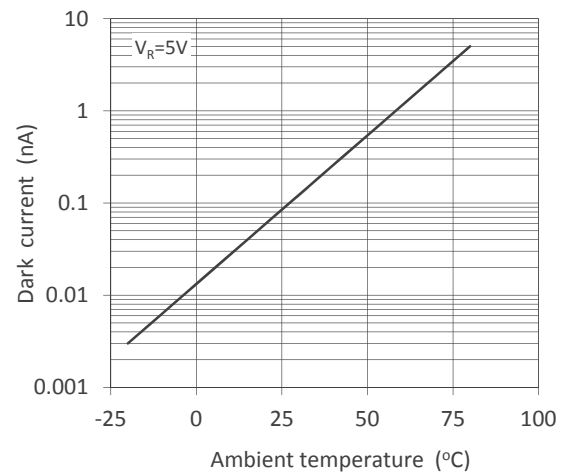

Spectral Responsivity

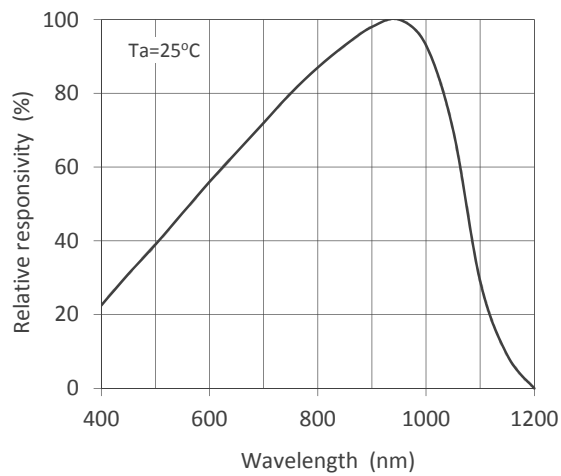

Directivity

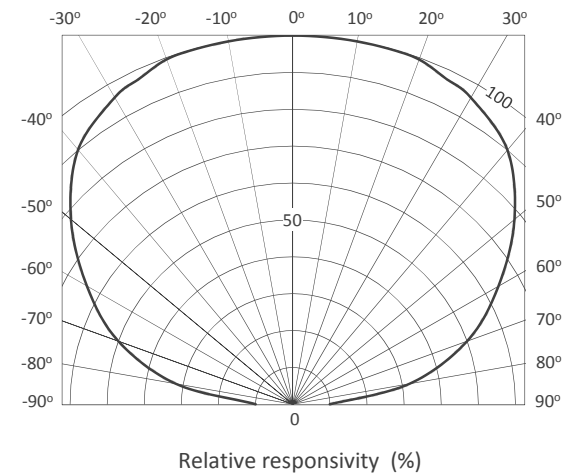

- Specifications, characteristics, data, materials, structures specified in this datasheet are subject to change without notice. Please refer to the latest specification before use of the products.
- Products listed in this datasheet comply with the RoHS Directive (EU2002/95/EC).

Opto-technologies for the Future



KYOSEMI CORPORATION

<http://www.kyosemi.co.jp/>

Headquarters : 949-2 Ebisucho Fushimi-ku, Kyoto 612-8201 Japan

TEL: +81-75-605-7311

Tokyo Sales Office: 24th Sky Bldg.2F, 1-34-3 Shinjuku Shinjuku-ku, Tokyo 160-0022 Japan

TEL: +81-3-5312-5360

Kansai Sales Office: 949-2 Ebisucho Fushimi-ku, Kyoto 612-8201 Japan

TEL: +81-75-605-7311

Kyosemi Opto America Corp: 4655 Old Ironsides Suite 230 Santa Clara, California 95054 USA

TEL: +1-408-492-9361

Eniwa Operation: 385-31 Toiso Eniwa-shi, Hokkaido 061-1405 Japan

TEL: +81-123-34-3111

Kamisunagawa Operation: 70-1 Kamisunagawa Kamisunagawa-cho Sorachi-gun, Hokkaido 073-0200 Japan

TEL: +81-125-62-3611